

REV.	DATE	DESCRIPTION	REVISION
02	06/28/05	REVISED PER CUSTOMER REQUEST	

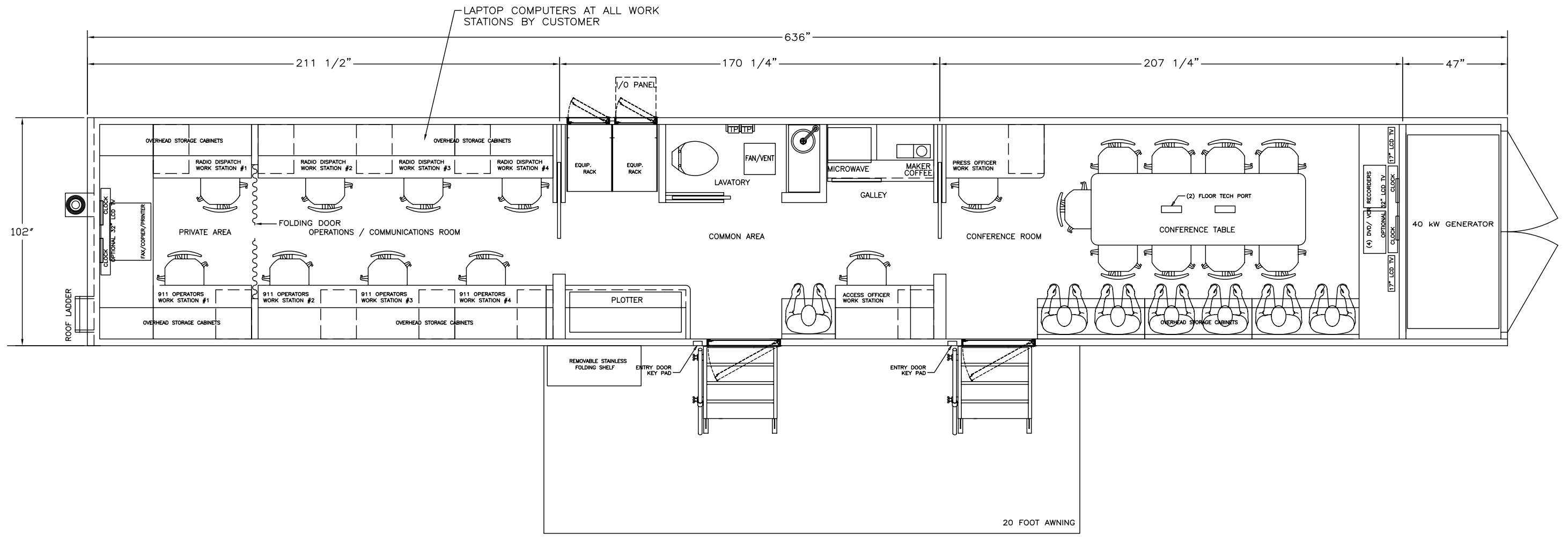
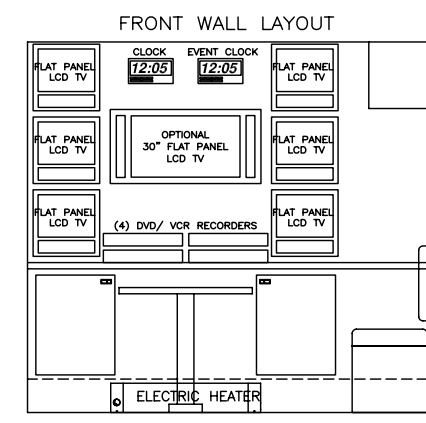
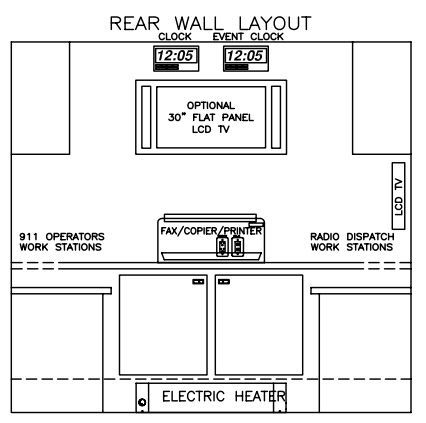

CUSTOMER APPROVAL

NAME: (print) _____

SIGNATURE: _____

TITLE: _____

DATE: _____

STATUS

PRELIMINARY SALES DRAWING

ALL DIMENSIONS

ARE APPROXIMATIONS

MBF Industries

210 TECH DRIVE
SANFORD, FLORIDA 32771

PHONE: 407-323-9414
FAX: 407-330-2068

DRAWING NUMBER	050012	REV	02	TITLE	LAKE COUNTY, FL 53' MOBILE COMMAND TRAILER		
TYPE	PROPOSAL	DATE	05/12/05	VIEW	INTERIOR PLAN LAYOUT		
<small>These drawings and/or specifications are the proprietary property and trade secrets of MBF Ind. and are issued in strict confidence. No reproduction or use shall be made without prior written consent of MBF Ind.</small>				DRAWN BY	JDK	SCALE	N/A
				SHEET	1 of 6	SIZE	B

REVISION		
REV.	DATE	DESCRIPTION
02	06/28/05	REVISED PER CUSTOMER REQUEST

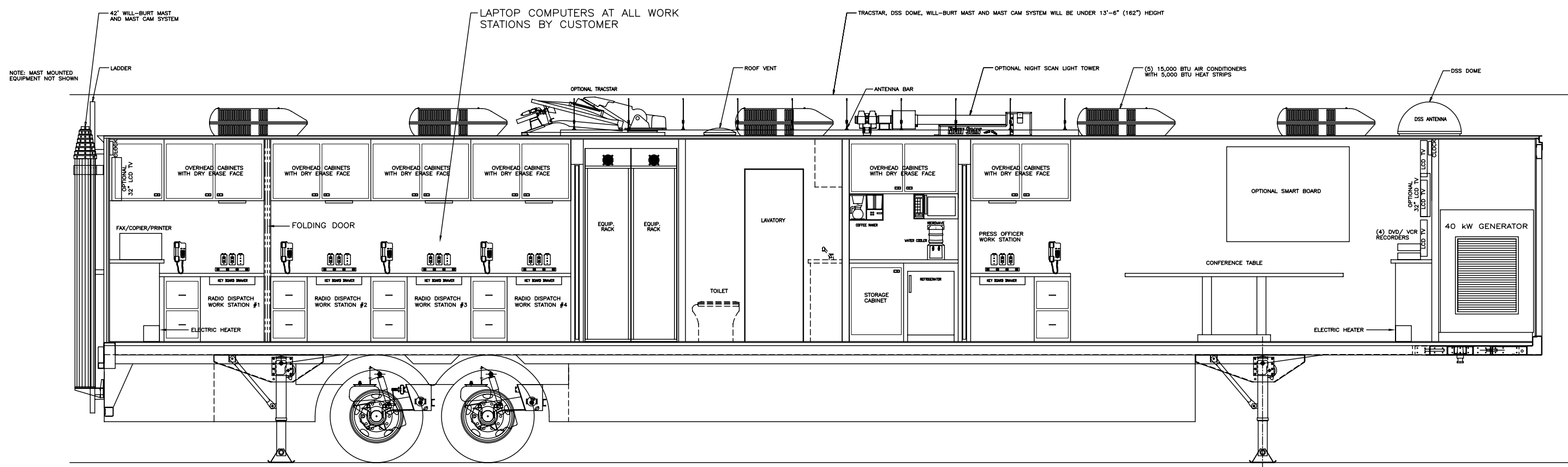

EXTERIOR CURB SIDE LAYOUT

<p>CUSTOMER APPROVAL</p> <p>NAME: (print) _____</p> <p>SIGNATURE: _____</p> <p>TITLE: _____</p> <p>DATE: _____</p>	<p>STATUS</p> <p>PRELIMINARY SALES DRAWING</p> <p>ALL DIMENSIONS</p> <p>ARE APPROXIMATIONS</p>	<p>MBF Industries</p> <p>210 TECH DRIVE SANFORD, FLORIDA 32771</p> <p>PHONE: 407-323-9414 FAX: 407-330-2068</p>	DRAWING NUMBER	REV	TITLE
			050012	02	LAKE COUNTY, FL 53' MOBILE COMMAND TRAILER
			TYPE	DATE	VIEW
			PROPOSAL	05/12/05	INTERIOR CURB SIDE LAYOUT
			<p>These drawings and/or specifications are the proprietary property and trade secrets of MBF Ind. and are issued in strict confidence. No reproduction or use shall be made without prior written consent of MBF Ind.</p>		DRAWN BY
					JDK
			SHEET	SCALE	
			2 of 6	N/A	
					SIZE
					B

REV.	DATE	DESCRIPTION	REVISION
02	06/28/05	REVISED PER CUSTOMER REQUEST	

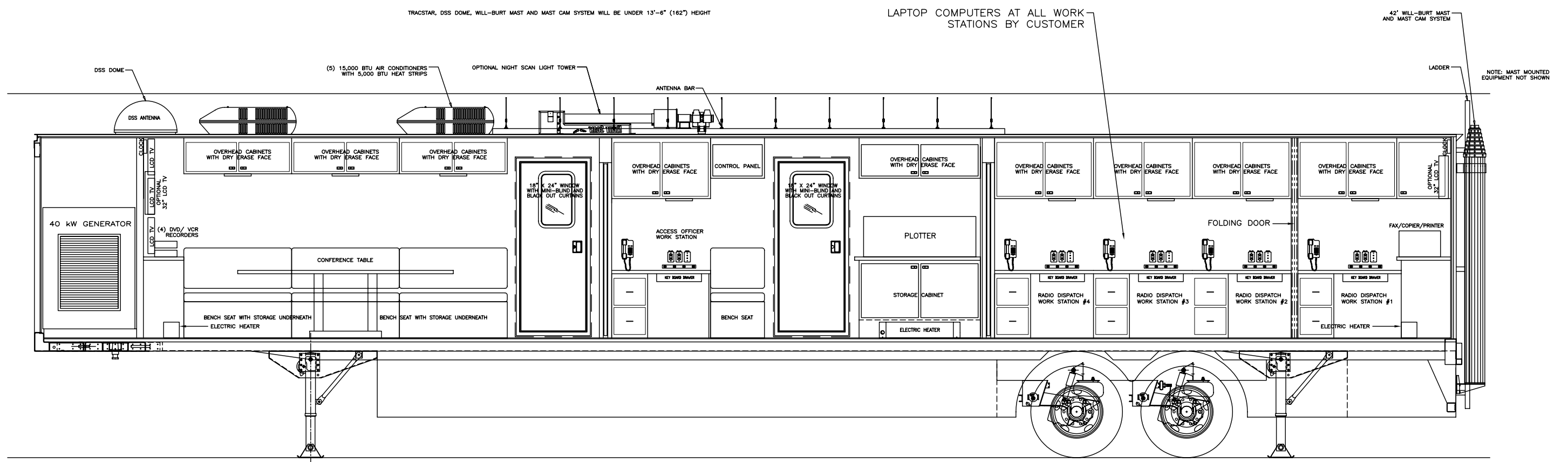

EXTERIOR ROAD SIDE LAYOUT

CUSTOMER APPROVAL
 NAME: (print) _____
 SIGNATURE: _____
 TITLE: _____
 DATE: _____

STATUS
PRELIMINARY SALES DRAWING
ALL DIMENSIONS
ARE APPROXIMATIONS

MBF Industries
 210 TECH DRIVE
 SANFORD, FLORIDA 32771
 PHONE: 407-323-9414
 FAX: 407-330-2068

DRAWING NUMBER	050012	REV	02	TITLE	LAKE COUNTY, FL 53' MOBILE COMMAND TRAILER		
TYPE	PROPOSAL	DATE	05/12/05	VIEW	EXTERIOR ROAD SIDE LAYOUT		
<small>These drawings and/or specifications are the proprietary property and trade secrets of MBF Ind. and are issued in strict confidence. No reproduction or use shall be made without prior written consent of MBF Ind.</small>				DRAWN BY	JDK	SCALE	N/A
				SHEET	3 of 6	SIZE	B

REV.	DATE	DESCRIPTION	REVISION
02	06/28/05	REVISED PER CUSTOMER REQUEST	

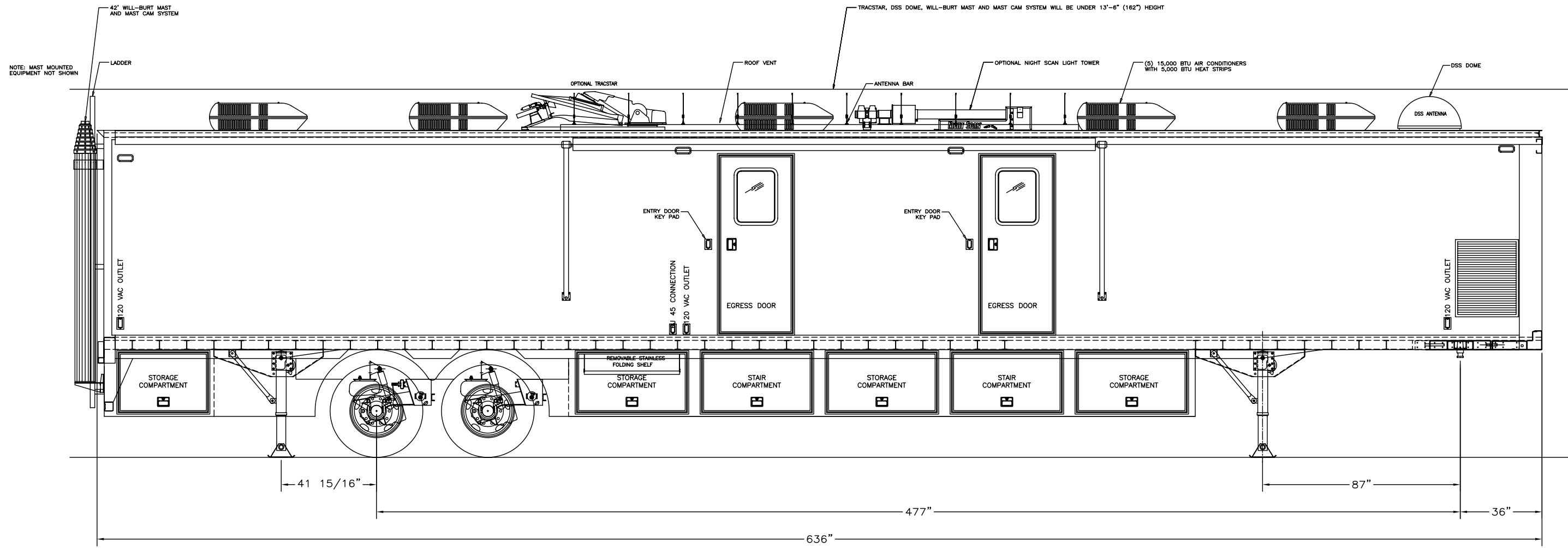

EXTERIOR CURB SIDE LAYOUT

<p>CUSTOMER APPROVAL</p> <p>NAME: (print) _____</p> <p>SIGNATURE: _____</p> <p>TITLE: _____</p> <p>DATE: _____</p>	<p>STATUS</p> <p>PRELIMINARY SALES DRAWING</p> <p>ALL DIMENSIONS</p> <p>ARE APPROXIMATIONS</p>	<p>MBF Industries</p> <p>210 TECH DRIVE SANFORD, FLORIDA 32771</p> <p>PHONE: 407-323-9414 FAX: 407-330-2068</p>	DRAWING NUMBER	050012	REV	02	TITLE	LAKE COUNTY, FL 53' MOBILE COMMAND TRAILER	
			TYPE	PROPOSAL	DATE	05/12/05	VIEW	INTERIOR CURB SIDE LAYOUT	
			<p><small>These drawings and/or specifications are the proprietary property and trade secrets of MBF Ind. and are issued in strict confidence. No reproduction or use shall be made without prior written consent of MBF Ind.</small></p>				DRAWN BY	JDK	SCALE
				SHEET	4 of 6			SIZE	B

REVISION		
REV.	DATE	DESCRIPTION
02	06/28/05	REVISED PER CUSTOMER REQUEST

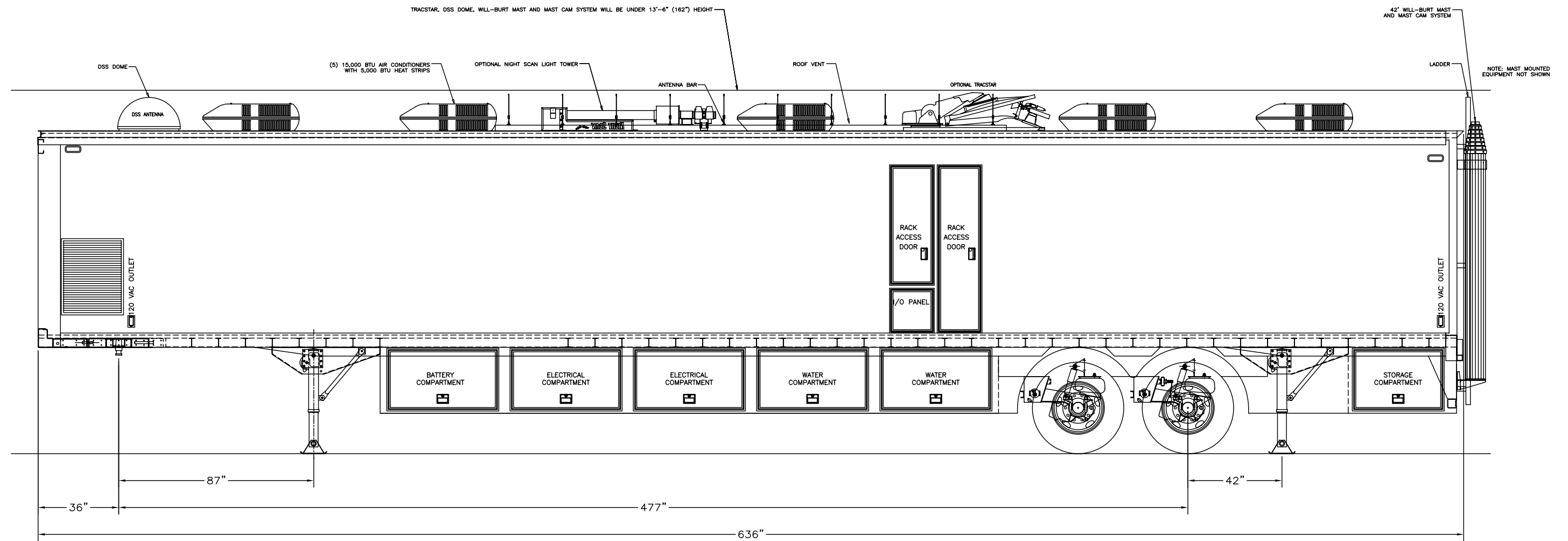

EXTERIOR ROAD SIDE LAYOUT

CUSTOMER APPROVAL

NAME: (print) _____
SIGNATURE: _____
TITLE: _____
DATE: _____

STATUS

**PRELIMINARY SALES DRAWING
ALL DIMENSIONS
ARE APPROXIMATIONS**

MBF Industries

210 TECH DRIVE
SANFORD, FLORIDA 32771

PHONE: 407-323-9414
FAX: 407-330-2068

DRAWING NUMBER 050012		REV 02	TITLE LAKE COUNTY, FL 53' MOBILE COMMAND TRAILER	
TYPE PROPOSAL	DATE 05/12/05	VIEW EXTERIOR ROAD SIDE LAYOUT		
<small>These drawings and/or specifications are the proprietary property and trade secrets of MBF Ind. and are issued in strict confidence. No reproduction or use shall be made without prior written consent of MBF Ind.</small>		DRAWN BY JDK	SCALE N/A	SIZE B
		SHEET 5 of 6		

REVISION		
REV.	DATE	DESCRIPTION
02	06/28/05	REVISED PER CUSTOMER REQUEST

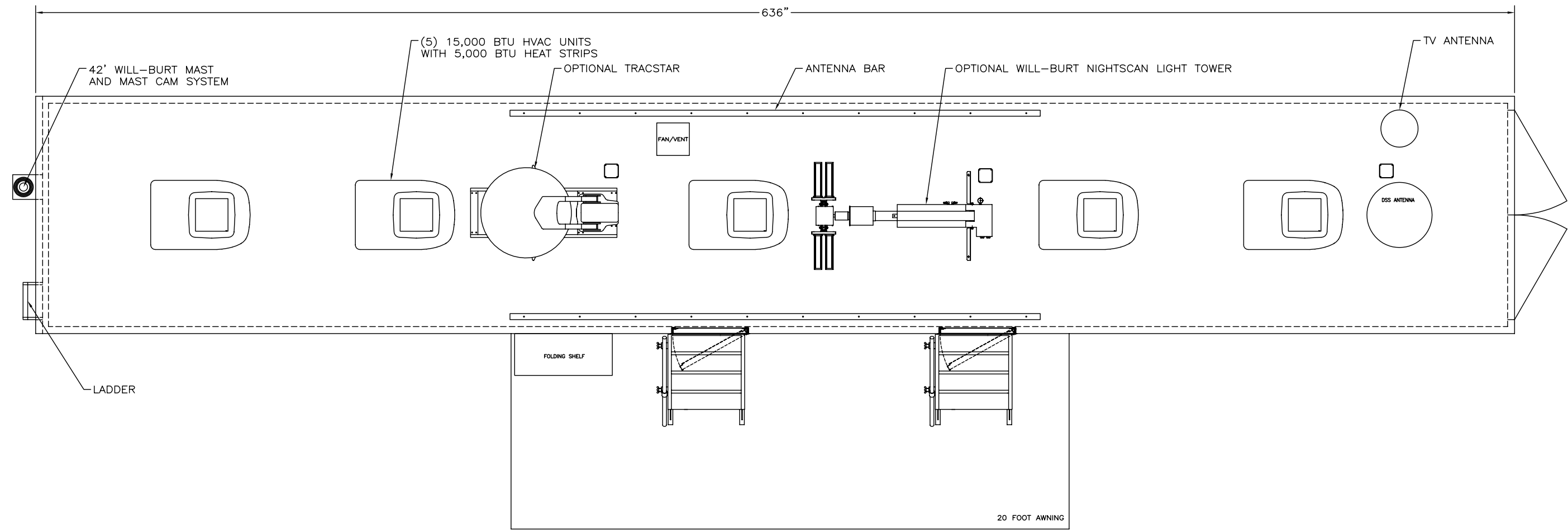

EXTERIOR ROOF LAYOUT

CUSTOMER APPROVAL
 NAME: (print) _____
 SIGNATURE: _____
 TITLE: _____
 DATE: _____

STATUS
PRELIMINARY SALES DRAWING
ALL DIMENSIONS
ARE APPROXIMATIONS

MBF Industries
 210 TECH DRIVE
 SANFORD, FLORIDA 32771
 PHONE: 407-323-9414
 FAX: 407-330-2068

DRAWING NUMBER 050012		REV 02	TITLE LAKE COUNTY, FL 53' MOBILE COMMAND TRAILER	
TYPE PROPOSAL		DATE 05/12/05	VIEW EXTERIOR ROOF LAYOUT	
<small>These drawings and/or specifications are the proprietary property and trade secrets of MBF Ind. and are issued in strict confidence. No reproduction or use shall be made without prior written consent of MBF Ind.</small>			DRAWN BY JDK	SCALE N/A
			SHEET 6 of 6	SIZE B